

# Digital Mug Heat Press Manual

## Model No.: MP-60

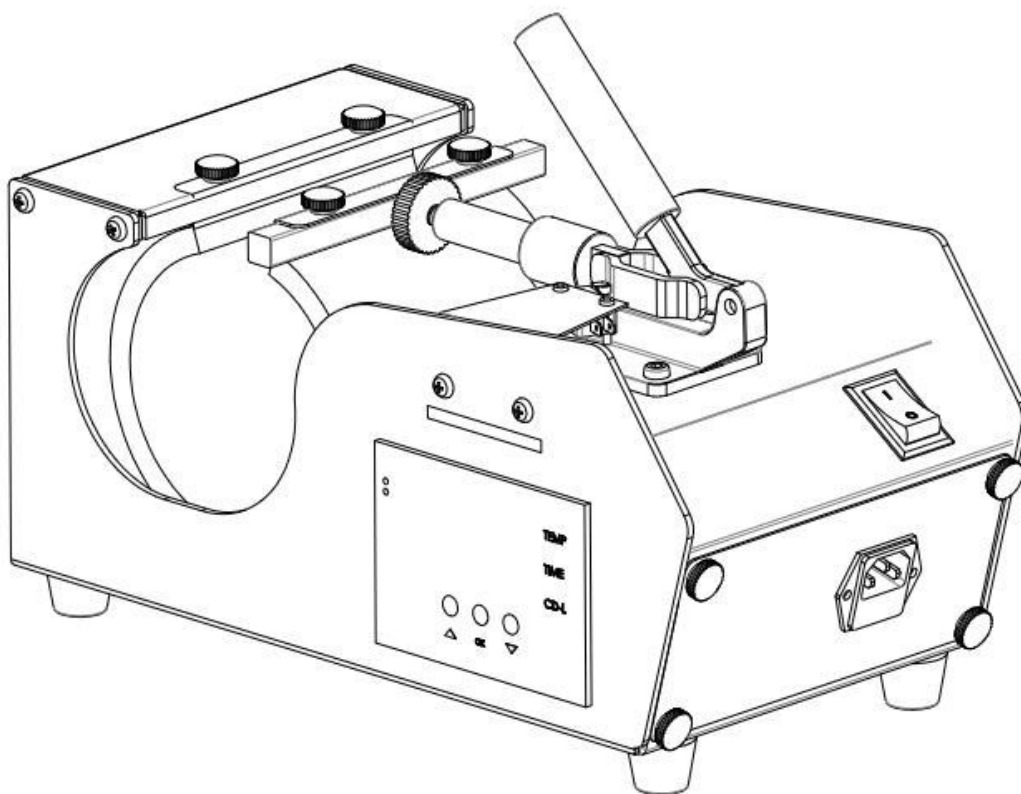

### CONTENTS

1. Technical Parameters	2
2. Operation Process	2-3
3. Maintenance	4
4. Explosion View	5
5. Circuit Diagram	6

## I. Assembly Drawing

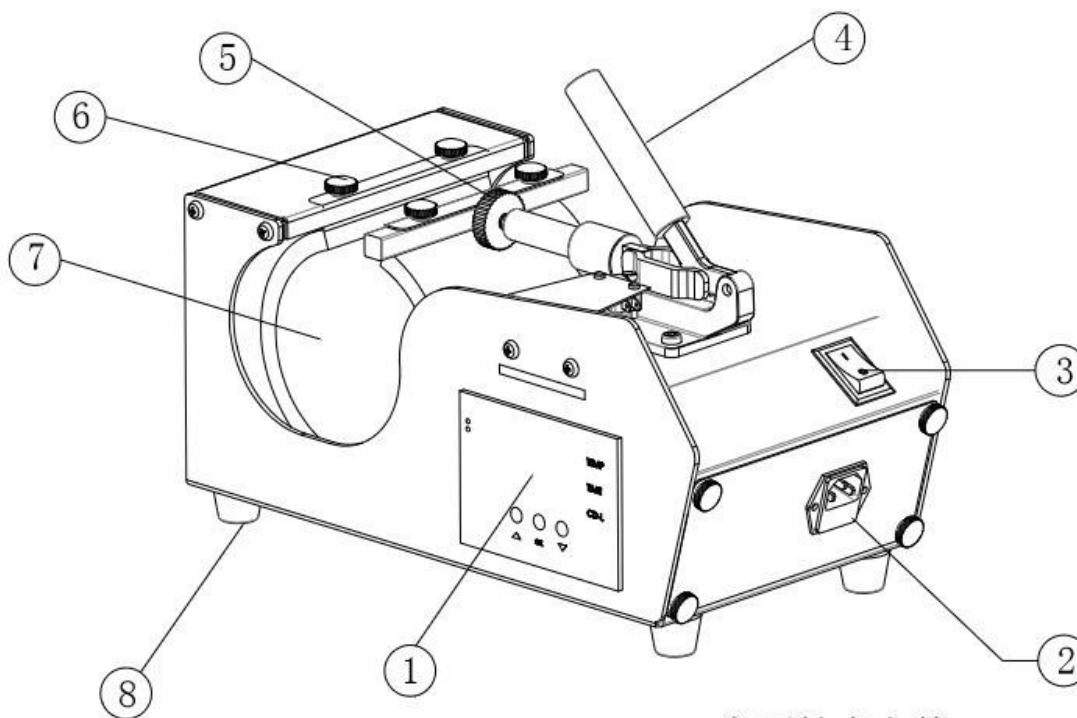

- |                             |                          |                 |
|-----------------------------|--------------------------|-----------------|
| 1. GY-04 Digital Controller | 2. Power Socket          | 3. Power Switch |
| 4. Toggle                   | 5. Pressure Adjust Screw | 6. M5 Screw     |
| 7. Mug Heater               | 8. Machine Feet          |                 |







## II. Technical Parameters

### MP-60 Technical Parameters

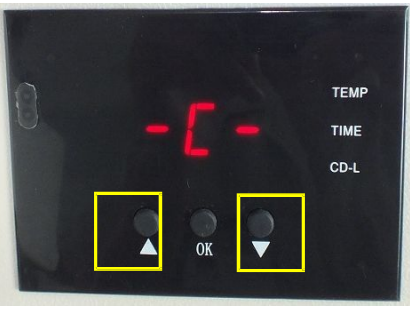







1. Model No.: MP-60
2. Machine Dimension : 350\*220\*256mm
3. Printable Articles Max Size:  $\varnothing$ 100\*120mm
4. Voltage:220V/1Phase;120V/1Phase
5. Power:0.2KW
6. Time range:0-999S  
Recommend setting:30-280S,180-210°C
7. Packing size: 460\*300\*335mm

### III. Operating Process

#### 1. Set temperature required

		
<p>Turn on power switch, temperature light is ON. The digital display shows</p> 	<p>Press  button, the  light is on (C denotes Celsius). Press arrows “△” or “▽” to select “°C” or “°F” (F denotes Fahrenheit) according to your habits.</p>	<p>Press  button, the temp  light is on. Select with arrows the temperature according to different transfer material (Normally 180°C~200°C)</p>

#### 2. Set time required

		
<p>Press  button after temperature setting and the  time light is on. Select with arrows the time according to different transfer material.</p>	<p>Press  button after time setting; the display shows the temperature starts to rise. “CD-L” shows the time counting down during your transfer.</p>	<p>Note: When the temperature shows on the display is not the same as actual temperature on heat platen, press  button for 5 seconds to enter the P5 mode:          When display shows 200°C, the actual heat platen temperature is 180 °C, Press arrows “△” to set to 20, and then press  button 5 seconds return to operation mode.          When display shows 200°C, the actual heat platen temperature is 220 °C, Press arrows “▽” to set to -20, and then press  button 5 seconds return to operation mode.</p>

#### 3. Printing methods

- Step 1: Make sure the cord is connected well to the wall socket. Place the mug in the mug heater, and transfer paper with images facing down the mug, adjust moderate pressure, and power on.  
 P.S: use heat resistant tape to fix the transfer paper, make sure transfer paper is exactly attached to mug heater;
- Step 2: Set the temperature and time required, then temperature starts to rise.
- Step 3: When the temperature rises to the setting temperature, the buzzer sends out sounds; then press the handle, (meantime the sounds stop) and starts to transfer.
- Step 4: Then the time counter is on, once time is up, take out the mugs. Transfer work finished.

**4. Recommendations:**

Ceramic Mug transfer: Set temperature: 180°C. Set time: 150 seconds

**V. Maintenance****1. No action after turn on the machine**

- 1). Check the plug whether it connects well or whether it is broken.
- 2). Check the power switch or digital controller whether it is broken.
- 3). Check the fuse whether it has been burnt out.
- 4). Indicating light is on, but no display on screen, check the 5 cable of Railway transformer. If it's loosening, showing the problem is poor connection. If they connects well, showing that the Transformer is faulty.

**2. The display screen are working well, but no temperature increasing on the mug heater.**

- 1). Check whether the thermocouple of the mug heater touches well. If the thermocouple is loose, the display will show 255°C. and machine keeps beeping.
- 2). Check if the indicating light of solid-state relay is on, if not, check if the relay or digital controller is broken.
- 3). If you already changed the new solid-state relay but the mug heater still can't heating up, check if the mug heater is faulty or the mug heater's power cable is loose, need to change by new mug heater.

**3. The display screen show 255°C once you power on.**

- 1). Check whether the thermocouple is loose or not.
- 2). If the thermocouple touches is not in loose state, but still show 255°C, then it is faulty.

**4. The machine is heating during 0~180°C, but display number jumps to above 200°C or 300°C suddenly, or the numbers on display jumps irregularly.**

- 1). Check whether the thermocouple of the mug heater touches well.
- 2). If the thermocouple is good, It shows that the program of digital controller is broken, which namely IC or is broken, need to change by new controller.

**5. The temperature is out of control: Set 180°C, but the actual temperature is above 200°C.**

- 1). It means the solid-state relay is broken, out of control, need to change the relay.
- 2). Or the digital controller is faulty and it keeps conveying electric to relay, need to change controller.

**6. The setting temp and time becomes abnormal after exchange the mug heater.**

- 1). Please reset the temp and time according the operation process manual.

**7. Other notice**

- 1). In order to prolong the machine service life, please add the lubrication oil regularly on the joints.
- 2). In order to keep the mug heater's good transfer effect, pls protect it carefully whenever you are using or not.
- 3). Please keep the machine in dry place.
- 4). The mug heater is belong to consumables. You need to change a new one after doing transfer print for about 700 times. If use our Grade A mug heater, then can change mug heater after 2000 times transfer.
- 5). If you are not able to solve the electrical parts problem, please kindly contact the supplier and get technical support.

**IV. Trouble shooting for transfer print quality**

1. If the print color is pale: the temperature is too low / the pressure is not correct / or not pressed long enough.
2. If the print color is too brown or the transfer paper is almost burnt: reduce the setting temperature.
2. If the print is blurring: too much transfer time causes proliferation.
3. If print color is different/ partial transfer effect is not good enough: the pressure is not enough / or notpressed long enough / or poor quality transfer paper.
4. If transfer paper stick to the object after transfer: the temperature is too high/ or poor quality printing ink.

## VI. Circuit Diagram

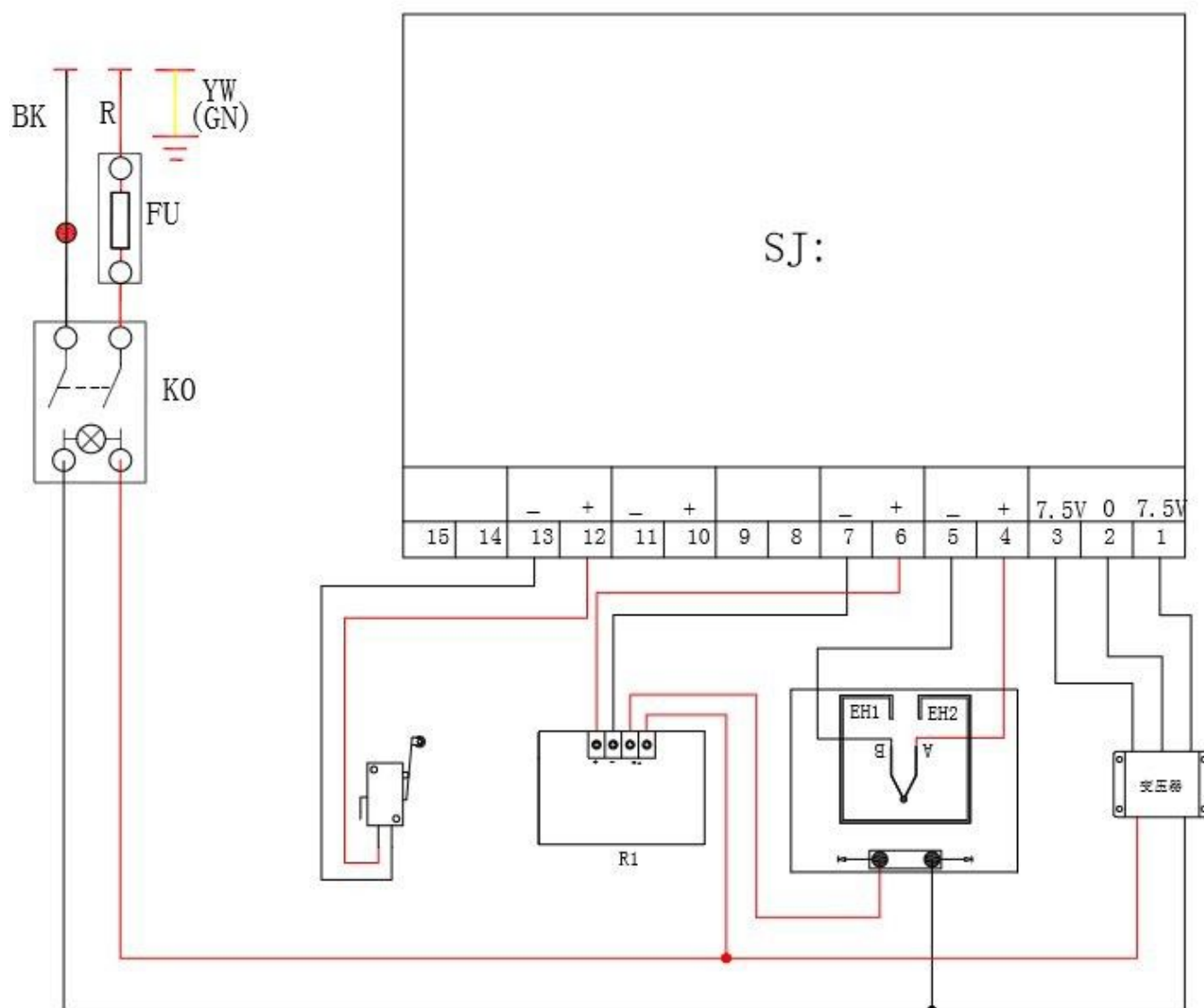

K<sub>0</sub>: Power Switch  
 FU: Fuse  
 SJ: Digital Controller  
 R1: Relay

T: Transformer  
 EH<sub>1</sub>EH<sub>2</sub>: Heating Pipe

## VII. Explosion View

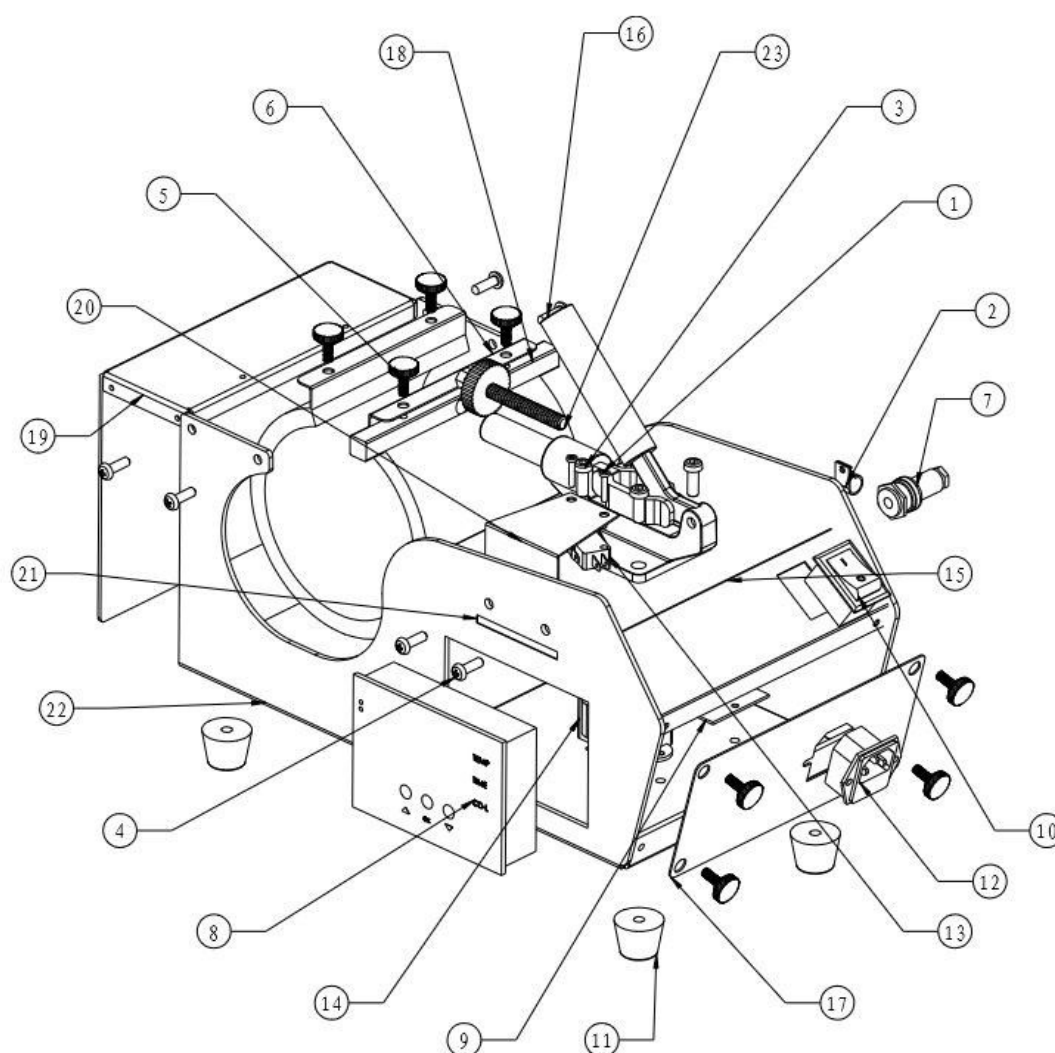

Item	Part Name	Specification	Quantity
1	Cross round head screw	M3*15	2
2	Wire clasps		1
3	Hex head screw	M6*15	4
4	Cross half-round screw	M5*10	6
5	Screw with plastic		8
6	Mug heater	235*120	1
7	Aerial socket		1/set
8	GY-04 digital controller	GY-04	1
9	Low power relay		1
10	Rocker Switch		1
11	Machine foot		4
12	Power socket		1
13	Limit Switch		1

14	Transformer		1
15	Decorating plate		1
16	Toggle clamp		1
17	Socket mounting plate		1
18	Fixed aluminum bar		1
19	Pressure adjust screw		1
20	Back support plate		
21	Bracket for limit switch		1
22	Bracket for toggle clamp		1
23	Machine frame		1